

Haltech

ELITE 1000/1500

Mazda 13B EV1

*Terminated Main Harness
(HT - 130307)*

QUICK START GUIDE

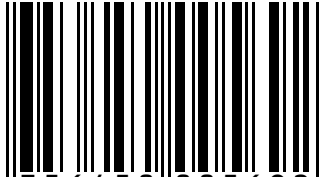

9 356450 005692

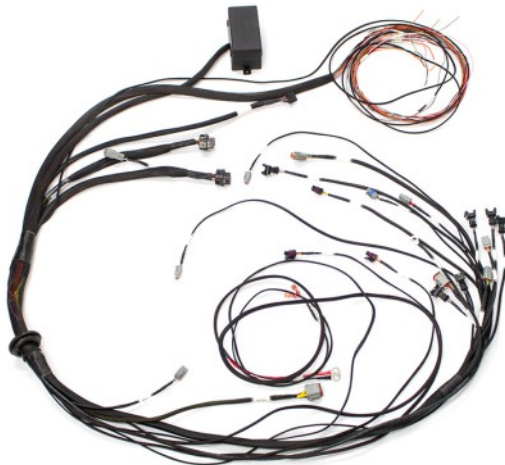

WARNING - HALTECH OFF-ROAD USAGE POLICY

It is unlawful to tamper with your vehicle's emissions equipment.

Haltech products are designed and sold for sanctioned off-road/competition non-emissions controlled vehicles only. Using Haltech products for street/road use on public roads is prohibited by law. It is the responsibility of the installer and/or user of this product to ensure compliance with all applicable local and federal laws and regulations. Please check with your local vehicle authority before using any Haltech product

INSTALLATION OF HALTECH PRODUCTS

No responsibility whatsoever is accepted by Haltech for the fitment of Haltech Products. The onus is clearly on the installer to ensure that both their knowledge and the parts selected are correct for that particular application. Any damage to parts or consequential damage or costs resulting from the incorrect installation of Haltech products are totally the responsibility of the installer.

Always disconnect the battery when doing electrical work on your vehicle. Avoid sparks, open flames or use of electrical devices near flammable substances. Do not run the engine with a battery charger connected as this could damage the ECU and other electrical equipment. Do not overcharge the battery or reverse the polarity of the battery or any charging unit. Disconnect the Haltech ECU from the electrical system whenever doing any welding on the vehicle by unplugging the wiring harness connector from the ECU. After completing the ECU installation, make sure there is no wiring left un-insulated. Uninsulated wiring can cause sparks, short circuits and in some cases fire. Before attempting to run the engine ensure there are no leaks in the fuel system. All fuel system components and wiring should be mounted away from heat sources, shielded if necessary and well ventilated. Always ensure that you follow workshop safety procedures. If you're working underneath a jacked-up car, always use safety stands!

HALTECH LIMITED WARRANTY

Unless specified otherwise, Haltech warrants its products to be free from defects in material or workmanship for a period of 12 months from the date of purchase, valid in the original country of purchase only. Proof of purchase, in the form of a bill of sale or receipted invoice, which indicates that the product is within the warranty period, must be presented to obtain warranty service. Haltech suggests that the purchaser retain the dealer's dated bill of sale/receipt as evidence of the date of retail purchase. If the Haltech product is found to be defective as mentioned above, it will be replaced or repaired if returned prepaid along with proof of purchase. This shall constitute the sole liability of Haltech. To the extent permitted by law, the foregoing is exclusive and in lieu of all other warranties or representations, either expressed or implied, including any implied warranty of merchantability or fitness. In no event shall Haltech be liable for special or consequential damages.

PRODUCT RETURNS

Please include a copy of the original purchase invoice along with the unused, undamaged product and its original packaging. Any product returned with missing accessory items or packaging will incur extra charges to return the item to a re-saleable condition. All product returns must be sent via a freight method with adequate tracking, insurance and proof of delivery services. Haltech will not be held responsible for product returns lost during transit. The sale of any sensor or accessory that is supplied in sealed packaging is strictly non-refundable if the sealed packaging has been opened or tampered with. This will be clearly noted on the product packaging. If you do not accept these terms please return the sensor in its original unopened packaging within 30 days for a full refund.

Returning a sensor or accessory product within 30 days of purchase: Product may be returned for credit or full refund. (Any sealed packaging must not have been opened or tampered with)

Returning a sensor or accessory product after 30 days of purchase: Product may be returned for credit only (no refunds given) and is subject to a 10% Restocking fee. (Any sealed packaging must not have been opened or tampered with)

Haltech 13B Terminated Engine Harness

Quick Start Guide

Congratulations on purchasing a Haltech Engine Management terminated engine harness. This *Plug and Play* product allows you to be up and running in a few hours.

The Harness when installed in conjunction with a Haltech Elite 1000 / 1500 ECU opens the door to virtually limitless performance modification and tuning of your vehicle. Programmable systems allow you to extract all the performance from your engine by delivering precisely the required amount of fuel and ignition timing that your engine requires for maximum output under all operating conditions.

This quick start guide will walk you through the installation of the Haltech Mazda 13B terminated engine harness into a vehicle. This guide is accompanied by the comprehensive help menu located within the NSP software that you or your tuner will need to refer to before completing your installation and configuration. The NSP software is located on the Haltech Resource Centre USB key provided with the ECU. The latest version of the software can also be downloaded from the Haltech website www.haltech.com

Supported Engine

The Haltech 13B terminated engine harness supports the following engine configurations

- Mazda 13B FC3S 2nd Gen Series 4 (mechanical oil metering)
- Mazda 13B FC3S 2nd Gen Series 5 (electronic oil metering)
- Mazda 13B FD3S 3rd Gen Series 6,7,8 with single turbo
- Mazda 12A engines (SEE NOTES)

NOTE: Mazda 12A engines can use this terminated harness when the engine has been fitted with an FC3S crank sensor or other supported crank sensor kits, along with supporting EFI hardware and sensors.

Supported ECU

- Haltech Elite 1000 /1500

Included in this package

- Haltech Mazda 13B terminated engine harness
- Connector pack

Optional Accessories (Sold Separately)

- Haltech Mazda 13B High Output IGN -1A Ignition Harness (HT-130336)
- Haltech Mazda 13B Flying Lead Ignition Harness (HT-130308)
- Haltech Mazda 13B S4 S5 CAS Harness (HT-130333)
- Haltech Mazda 13B S6 S7 S8 CAS Harness (HT-130334)
- Haltech "TI" 5 Bar Map Sensor (HT-010110)
- Haltech Air Temperature Sensor (HT-010200)
- Haltech Knock Sensor (HT-011100)
- Haltech LS1 Coil (HT-020102)
- Haltech 150PSI "TI" Fuel/Oil/Wastegate Pressure Sensor (HT-010904)

Harness Overview

The Haltech Mazda 13B terminated engine harness is a plug and play solution for wiring a Mazda Rotary 13B Engine (single turbo only).

Installation is simple and easy as the harness is designed for the engine, all lengths are correct and all wires are clearly labelled.

Notes on installation:

- Make sure your engine is grounded directly to the battery. A ground wire / earthing strap should also be used to ground your engine to the chassis of the vehicle. The Haltech terminated engine harness **does not** ground your engine.

WARNING!

Damage can occur to your harness and / or ECU if you do not ground your engine properly. Please ensure heavy gauge cable is used.

- Integrated alternator connection
- Integrated oil metering pump connection
- Integrated starter motor solenoid connection
- Keep all wires away from the exhaust manifold.
- Ignition harness sold separately.
- Internal 4 Bar or external Haltech 5 Bar "TI" MAP sensor required for use.

Basemap Overview

- Basemaps are supplied in generic form for FC3S and FD3S turbo engines, as well as 13B Bridge or Peripheral Port naturally aspirated engines. These have basic engine configuration set to allow initial starting of the engine.
- The 13B Turbo base map is based on an FC3S engine and is set to use the OEM 4x 550cc injectors. These values should be changed to suit the injectors that you will be using.
- The 13B Bridge Port / Peripheral Port base map is configured for naturally aspirated engines using the same 4x550cc injectors, and is set to use the TPS as the main load axis. The injector flow rates will also need to be set to match the injectors on the engine.
- Base maps supplied are not “race ready” and will require additional tuning to suit your particular engine and modifications. They are suggestive only and should be used as a guide only.
- All Inputs and Outputs have been pre-configured in the base maps, however some have been disabled by default. If you are using one of these disabled functions they will need to be enabled by entering the Main Setup, select Functions, and then clicking the appropriate Red box next to the function you want to enable, which should then make the box change to Green.
- The ignition has been pre-configured for direct fire using the IGN1-A ignition coils. Direct Fire refers to their being 4x ignition coils with one coil per spark plug. If you are using an ignition system other than this you will need to adjust your settings to match.
- When using a crank trigger other than the factory fitted FD3S system ignition timing check should be performed.

Rotary Engine Specific Information

When using a Haltech Elite ECU with a Mazda Rotary engine the following information will assist with correct operation.

Injector Output Connection

For a rotary engine the injector outputs should be wired or assigned in the following order.

Injector Output 1 -> Front Rotor Primary Injector -> **PRIMARY INJ 1**

Injector Output 2 -> Rear Rotor Primary Injector -> **PRIMARY INJ 2**

Injector Output 3 -> Front Rotor Secondary Injector -> **SECONDARY INJ1**

Injector Output 4 -> Rear Rotor Secondary Injector -> **SECONDARY INJ2**

Staged Injection with an Elite ECU

The Elite ECU has a simple staging setup that does not reference engine RPM or Load. It will simply use the Primary Injectors Only up until the duty cycle exceeds the Maximum Stage Duty Cycle. It will then enable the Secondary Injector Stage and will operate all injectors at the same duty cycle until it falls below the Minimum Stage Duty Cycle. It will revert back to only using the Primary Injectors. This method is used so that the Secondary Injectors are only put to use when additional fuel is required that the Primary Injectors cannot supply.

When setting the Minimum Stage Duty Cycle consideration must be put towards setting an appropriate value. Eg. If all injectors flow the same amount, and the Maximum Stage Duty Cycle is set to 90% then when the Secondary Injectors are required the duty will naturally fall to 45%, so half as much duty. To ensure there is not oscillation the Minimum Stage Duty Cycle should be set to a value below 45%, so a value around 35 to 40% works well in preventing this oscillation. If the secondary injectors are much larger than the primary injectors then this value needs to be set much lower to avoid this issue. Starting with a low value around 5% and noting the amount of duty when the secondary injectors activate will help with finding an appropriate value to use.

Harness Connections

Main Power

The main power connections supply power through the harness and labelled as “**Battery +**” and “**Battery -**”. Please ensure these connections are connected after all other connections have completed and all unused in cabin wiring insulated.

The ECU main power consists of the following:

Injection Battery + (R)

The Injection Battery + (Red) connection will supply the 12V DC to the injector relay within the harness. Please connect this cable directly to the battery + terminal.

ECU Battery + (R/W)

The ECU Battery + (Red / White) connection will supply the 12V DC to the ECU relay within the harness. Please connect this cable directly to the battery + terminal.

Battery + (R/G)

The Battery + (Red/Green) connection will supply the 12V DC to the ignition and fuel pump relay within the harness. Please connect this cable directly to the battery + terminal.

Battery Ground (B)

The Battery Ground (Black) connection supplies battery ground for the harness. The battery ground lug consists of one cable terminated with a 10mm ID eyelet. Please connect this cable directly to the Battery (-) terminal.

WARNING!

Please make sure your engine block is grounded to the battery of the vehicle by a correctly sized grounding strap. This harness will not ground your engine. Damage can occur to this harness and / or your ECU if your engine is not properly grounded.

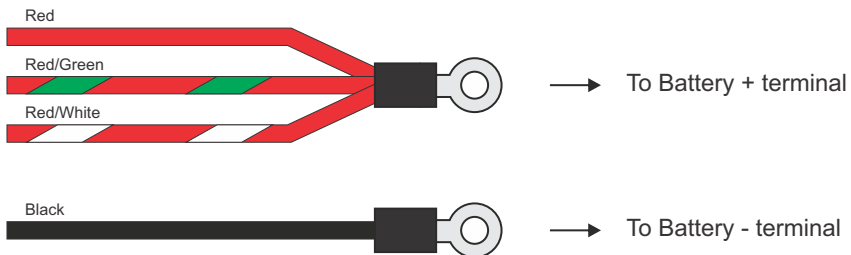

Figure 1 - Main Power Connections

Termination Description

Ignition Output Connector

The Ignition Output Connector comprises of the following connections:

Ignition Outputs (IGN1 - IGN4)

The Elite 1000 / 1500 13B terminated engine harness has two options for the ignition harness. Please select option upon ordering of your terminated harness kit:

- Haltech Mazda 13B Flying Lead Ignition Harness (HT-130308) - coils not included
- Haltech Mazda 13B High Output IGN -1A Ignition Harness (HT-130336) - coils not included

The chosen Ignition harness will connect to the 8 position connector labeled as "Ignition Outputs".

The Haltech Elite 1000 / 1500 cannot fire the coils directly, and an optional ignition module will need to be purchased if the IGN-1A ignition option is not chosen.

The Ignition Output Connector comprises of the following connections:

Ignition Outputs (IGN1 - IGN4)

These wires are the ignition outputs of the ECU and can be connected to the ignition module, or directly to the coil if coil has built in ignitors such as IGN-1A

Battery Ground (B)

This wire supplies a battery ground to the ignition module or coils

Signal Ground (B/W)

This wire supplies a signal ground to the ignition module or coils

+12V DC From Ignition Relay (R/Y)

This wire supplies a switched +12V DC to the coils from the ignition relay (R3) located inside the fusebox.

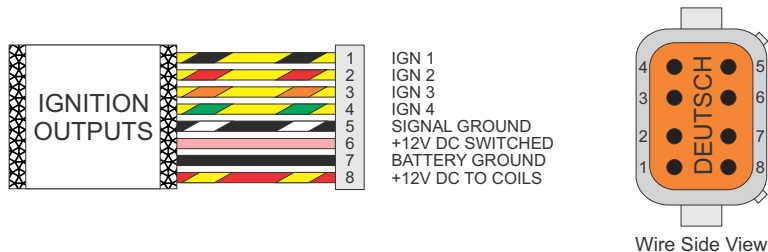

Figure 2 - Ignition Output Connector

Ignition Output Connection

When wiring an Elite ECU to a Mazda Rotary engine the following connections should be made:

- Ignition Output 1 -> Front Rotor Lead (Lower) -> **(LEAD #1)**
- Ignition Output 2 -> Rear Rotor Lead (Lower) -> **(LEAD #2)**
- Ignition Output 3 -> Front Rotor Trail (Upper) -> **(TRAIL #1)**
- Ignition Output 4 -> Rear Rotor Trail (Upper) -> **(TRAIL #2)**

Performing an Ignition Timing Check on a Rotary Engine

An ignition timing check should always be performed with any new ECU installation. This is to ensure that the ignition timing reported by the ECU matches with the amount seen with a timing light on the crank.

FC3S based engines have a timing pointer on the front cover and two timing marks, none of which are TDC. The yellow mark refers to -5 degrees (5 ATDC), and the orange mark refers to -20 degrees (20ATDC).

FD3S engines have a pointer on the front cover and a single notch on the crank trigger disc. This notch is at -20degrees (20ATDC).

The base maps have the Ignition Lock Mode values set to fire the Lead spark at -5 and the Trail at -20 (15deg split). Set the Ignition Lock Mode to Enabled and for either engine, when a timing light is connected to T1 (front rotor top spark plug lead) the pointer should be aligned with the Orange mark for the FC3S engine, or the notch for an FD3S engine. If it does not fire on these marks the TDC Offset needs to be increased or decreased until the timing mark aligns.

When performing a timing check on a Bridge Port or Peripheral Port engine it may struggle to run with only -5 degrees Lead ignition timing. It can help with these types of engines to lock the Lead timing at 20 and input a 40deg split. This will help the engine to idle and also will still fire the Trail spark at -20 (20ATDC) so the Trail timing marks can be checked without the engine running poorly.

For other front pulley variants you will need to enter timing values that correspond to your timing marks.

After performing the timing check you must set the Ignition Lock Mode back to Disabled.

Haltech Ignition Harness Overview

The Haltech 13B terminated engine harness has two ignition harnesses available. Please specify the harness required at time of purchase.

Haltech Flying Lead Ignition Harness (HT-130308)

The Haltech flying lead ignition harness is designed to allow the end user alternative options for their ignition system.

The Haltech flying lead ignition harness can be wired to existing ignition modules or used to trigger a CDI system.



Figure 3 - Haltech Flying Lead Ignition Harness Connections

Haltech High Output IGN-1A Inductive Coil Ignition Harness (HT-130336)

The Haltech high output IGN-1A inductive coil ignition harness is designed to be a plug and play solution when used with Haltech IGN-1A inductive coils (HT-020114) (with built in ignitor). With the additional purchase of four coils this harness will simply plug in. The use of Haltech IGN-1A inductive coils with your engine package will save you time and money, as these coils have inbuilt ignitors, so ignition modules will not need to be purchased.

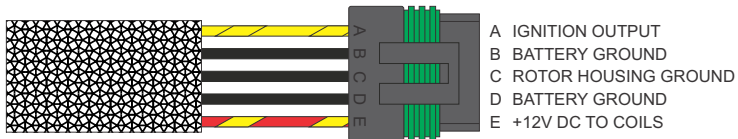

Figure 4 - Haltech High Output IGN-1A Inductive Coil Ignition Harness



Termination Description (Continued)

Injection 1 - 4 (INJ 1, INJ2, INJ3, INJ4)

The injector outputs connects directly to the injectors.

Please ensure the correct injector output is connected to the corresponding injector on the engine.

For a rotary engine the injector outputs should be wired or assigned in the following order.

Injector Output 1 -> Front Rotor Primary Injector -> **(PRIMARY INJ 1)**

Injector Output 2 -> Rear Rotor Primary Injector -> **(PRIMARY INJ 2)**

Injector Output 3 -> Front Rotor Secondary Injector -> **(SECONDARY INJ1)**

Injector Output 4 -> Rear Rotor Secondary Injector -> **(SECONDARY INJ2)**

Throttle Position Sensor (TPS) - AVI 10

The throttle position sensor measures the throttle butterfly rotation.

This harness has been fitted with a 3 pin connector to allow for the installation of the throttle position sensor.

The throttle position sensor comprises of the following connections:

Signal Ground (B/W)

This wire supplies the signal ground to the throttle position sensor

TPS Signal (W)

This wire is the signal to your ECU, Please connect this to the signal output of your throttle position sensor

+5V DC (O)

This wire supplies the throttle position sensor with an ignition switched +5V DC supply

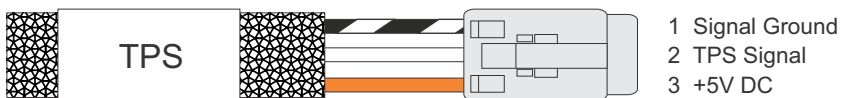

Figure 5 - Throttle Position Sensor Connections

Throttle Position Sensor Wiring

Connections to the throttle position sensor for both Series 5 and Series 6 engines are outlined below.

Note that the Series 4 engine has a sensor that only reads the first 1/3 of the throttle movement. This sensor will read 100% at 1/3 throttle opening. As such the sensor can be used but a better state of tune will be found by using the full range sensor found on the Series 5 throttle body.



Figure 6 - Series 5 Throttle Position Sensor Wiring

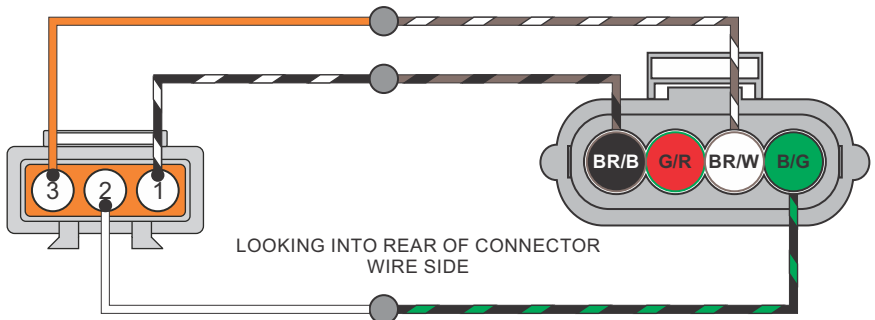

Figure 7 - Series 6 Throttle Position Sensor Wiring

Manifold Pressure Sensor (MAP)

A MAP sensor is required when tuning an engine to compensate for changes in air density due to pressure. The MAP sensor is used to convert the pressure of air in the intake into an electrical signal for the ECU to use as a reference for engine load. The sensor works in absolute pressures, thus its calibration is not affected by changes in barometric pressure.

This harness is provisioned with the ability to connect an external Haltech 5 bar "TI" MAP Sensor (HT-010110) via a pre-terminated connector. This sensor can be purchased separately from www.haltech.com.

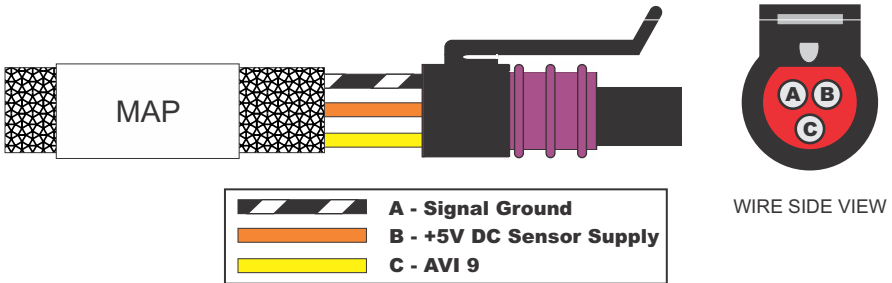
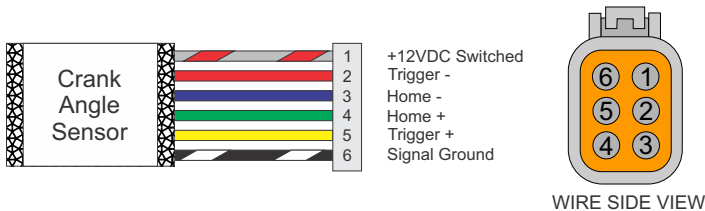

Figure 8 - Manifold Pressure Sensor Connections

Crankshaft Angle Sensor (CAS)

The Crankshaft Angle Sensor (CAS) is used to determine eccentric shaft position and stroke of the engine. There are two CAS sub-harnesses available to plug into the DTM-6 CAS connector breakout on this harness:



HT-130333 Mazda S4 S5 13B CAS sub-harness

HT-130334 Mazda S6 S7 S8 CAS sub-harness

Figure 9 - CAS breakout connector and sub-harness options (sold separately)

Oil Pressure Sensor (Oil-P) - AVI 4

The Oil-P labelled connector connects directly to a Haltech 150PSI "TI" pressure sensor (HT-010904).

This will enable the user to know the current oil pressure of the vehicle.

An optional oil pressure sensor can be purchased from www.haltech.com

The oil pressure sensor connection consist of:

Signal Ground (B/W)

This wire supplies the signal ground to the oil pressure sensor

Oil-P Signal (ORG/YEL) - AVI 4

This wire is the Analogue Voltage Input (AVI) signal to your ECU.

+5V DC (O)

This wire supplies the Oil Pressure Sensor with an ignition switched +5V DC supply

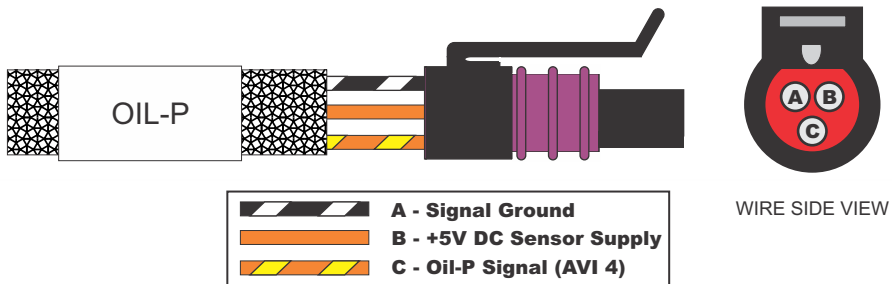

Figure 10 - Oil Pressure Sensor Connections

Intake Air Temperature Sensor (IAT) - AVI 7

An air temperature sensor is a required sensor used in Volumetric Efficiency (VE) tuning to compensate for changes in air density due to air temperature. Cold air has a higher density than warm air and therefore requires a greater volume of fuel to maintain the same air/fuel ratio. For this reason an air temperature sensor (HT-010200) can be used as a substitute to the factory air temperature sensor. The sensor needs to be mounted after any turbo/intercooler in the moving airstream to give fast response times and reduce heat soak effects.

Engine Coolant Temperature Sensor (CTS) - AVI 8

The engine coolant temperature sensor provides the ECU with a signal that allows the ECU to know the current engine temperature. This harness has been fitted with an OEM coolant temperature sensor connector.

Fuel Pressure Sensor (Fuel-P) - AVI 3

The Fuel-P labelled connector connects directly to a Haltech Fuel Pressure Sensor (HT-010904). This will enable the user to know the current fuel pressure of the vehicle. An optional fuel pressure sensor may be purchased from www.haltech.com

The fuel pressure sensor connection consist of:

Signal Ground (B/W)

This wire supplies the signal ground to the fuel pressure sensor.

Fuel-P Signal (ORG/RED) - AVI 3

This wire is the Analogue Voltage Input (AVI) signal to your ECU.

+5V DC (O)

This wire supplies the fuel pressure sensor with an ignition switched +5V DC supply

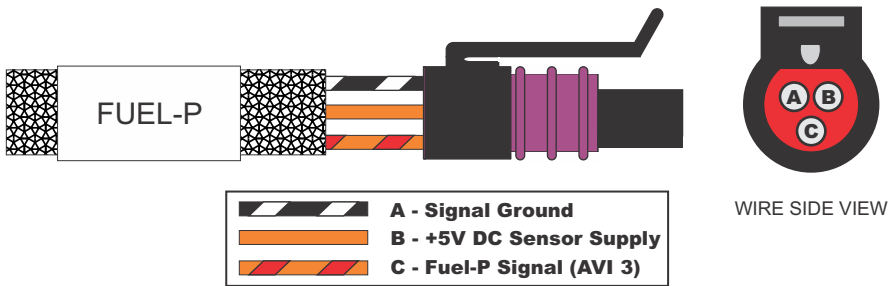

Figure 11 - Fuel Pressure Sensor Connections

Knock Sensor (KNOCK)

The Knock labelled connector connects directly to an optional Haltech Knock Sensor (HT-011100) mounted to the block of the engine. The signal is used by the ECU knock control function to detect knock events within the engine.

This sensor can be purchased separately from www.haltech.com.

Spare Synchronised Pulsed Inputs (SPI4)

There is one Synchronised Pulsed Input (SPI) connector located on the Haltech Mazda 13B series terminated engine harness (SPI4).

This connection consist of:

- +12V DC Sensor Supply
- Signal Ground
- Synchronized Pulsed Input

Spare SPI4 come pre-terminated with 3 pin connector.

These input can be programmed within the NSP Software to read inputs such as:

- Vehicle Speed Sensor
- A/C Request Switch
- Flex Fuel Composition Sensor
- Fuel Flow Sensor
- Clutch Switch

For a full list of output options and explanations please go to the help section within the NSP Software.

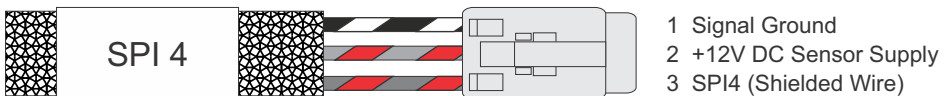

Figure 12 - Spare SPI4 input

*SPI4

This input is pre-configured for Flex Fuel Sensor but disabled within the supplied basemap. Please enable / reconfigure if required.

Spare DPO (DPO 2, DPO 4)

There are two Spare Digital Pulsed Outputs (DPO) connectors located on the Haltech Mazda 13B series terminated engine harness. (DPO2, DPO4). These connections consist of:

- +12V DC Sensor Supply
- Digital Pulsed Output

When the output is activated by the ECU, the output will switch to ground. Devices such as solenoid valves and shift lights can be run directly from the output provided that they do not exceed the maximum current draw of 1A, however high current devices such as thermofans and additional fuel pumps must be activated through a relay. A relay can be wired between the DPO and the supplied +12V DC on this connector. This way the output is only switching the relay and not a high current draw device.

The Digital Pulsed Outputs are limited to 1A Max current draw.

These outputs can be programmed within the NSP Software to control auxiliaries such as:

- A/C Output
- Aux Fuel Pump
- Boost Control
- Check Engine Light
- Intercooler Spray
- Shift Lights
- Thermofans

For a full list of output options and explanations please go to the help section within the NSP Software.

*DPO2

This output is pre-configured for Boost Control Solenoid but disabled within the supplied basemap. Please enable / reconfigure if required.

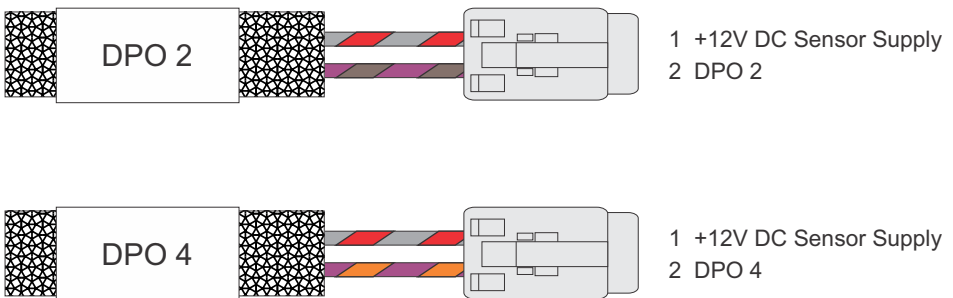

Figure 13 - Spare DPO2 / DPO4 Connections

Alternator Regulation (ALT)

The Haltech Mazda 13B series terminated engine harness is provisioned with an alternator regulator control connector. This connector consists of the following connections:

- +12V DC Battery + (Connected to Battery + via Haltech fuse box)
- ECU Injector Power (Connected to Injector Relay Output via 470R Resistor Load)
- ECU Injector Power (Connected to Injector Relay Output)

Alternator regulator connection comes pre-terminated with 3 pin connector.

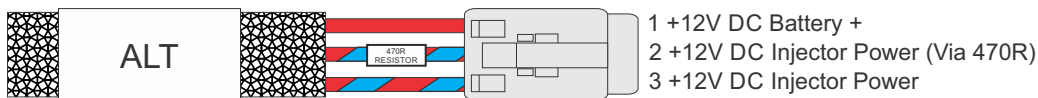

Figure 14 - Alternator Input

Starter Motor Solenoid (STS)

The starter signal connects directly to starter motor solenoid. This will supply +12V to the solenoid on receiving a start signal from the ignition switch when in the start position.

Please ensure you supply main power connection to the starter motor and a main earth strap to the engine to ensure correct operation of the starter motor and to avoid damage to your terminated harness and ECU.

For the full list of input options and explanations please go to the help section within the NSP Software.

Haltech CAN wideband O2 controller kits - purchased separately

Wideband O2 sensors accurately measure the Air / Fuel ratio of the engine which is required for precise tuning and control of the engine.

This harness is fitted with a DTM-4 CAN plug to connect to Haltech CAN devices such as a single or dual channel wideband controller kit:



HT-159976 - Haltech single channel Bosch wideband controller kit



HT-159986 - Haltech dual channel Bosch wideband controller kit

NOTE: Make sure to follow the power and ground wiring instructions found in the quick start guide included with the above wideband controller kits.

Oil Metering Pump

An oil metering pump is used to inject a small amount of engine oil from the oil pan into the intake manifold or directly into the combustion chamber in order to provide lubrication for apex seals.

This harness has been provisioned with an 8 pin connector which will allow you to wire an OEM electronic metering pump.

This connector consist of the following connections:

- Stepper 1 P1
- Stepper 1 P2
- Stepper 1 P3
- Stepper 1 P4
- Signal Ground
- Analogue Voltage Input (AVI1)
- +5V DC supply

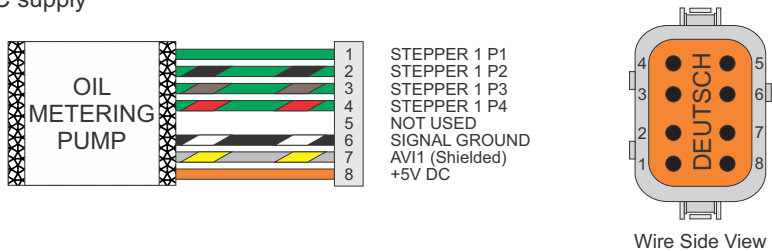

Figure 15 - Oil Metering Pump Connection

Oil Metering Pump Wiring

Connections to the electronic oil metering pump for both series 5 and series 6 engines are outlined on the next page.

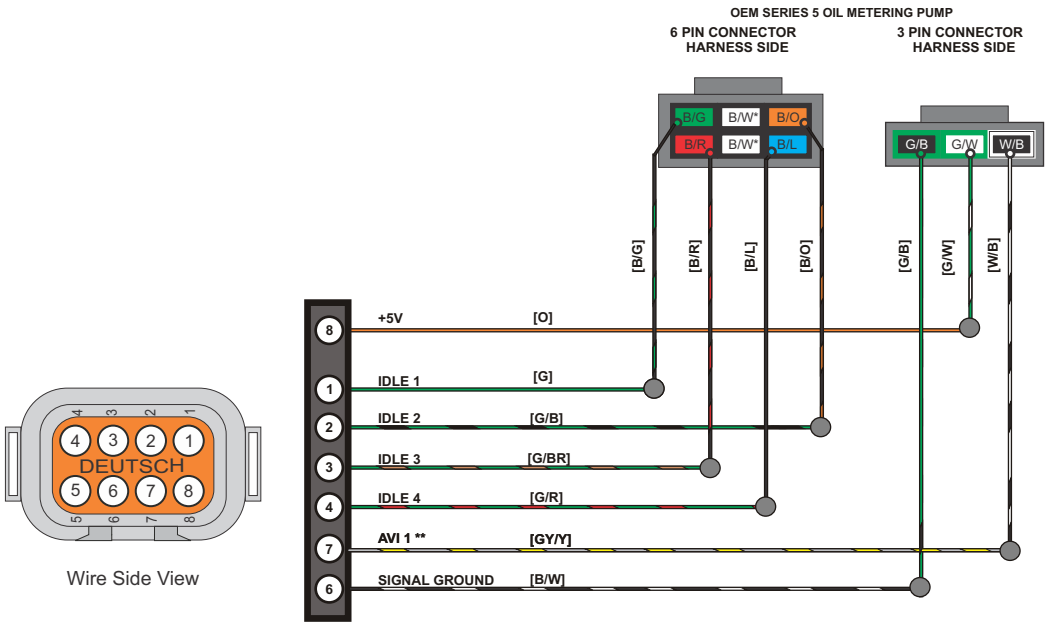

Figure 15 - S5 Oil Metering Pump Connection

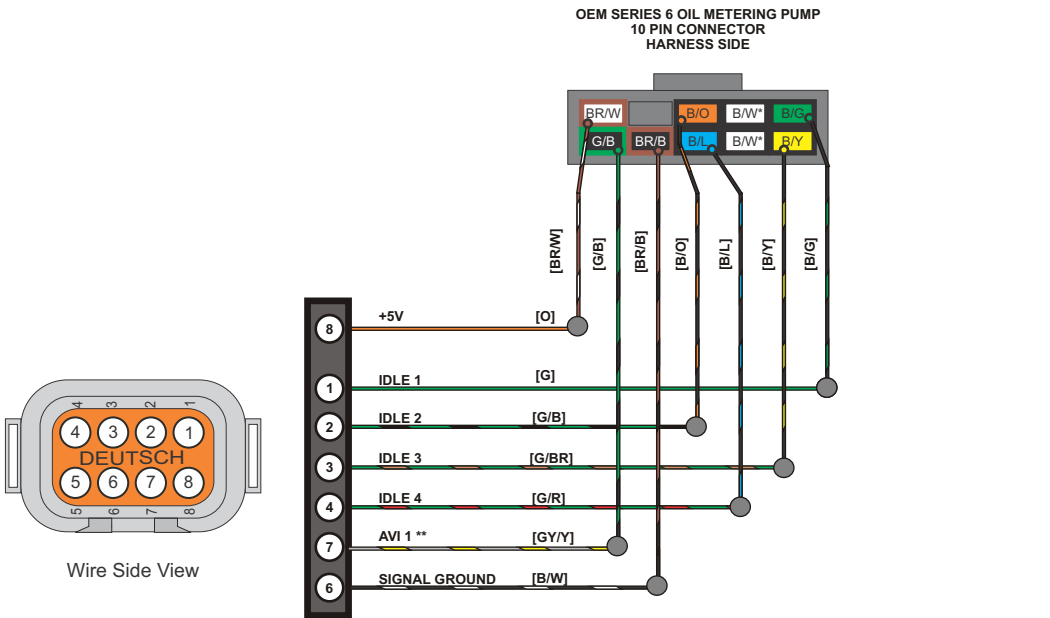

Figure 16 - S6 Oil Metering Pump Connection

In Cabin Harness

The In Cabin Harness wiring is made up of multiple inputs and outputs. Correct connection of these wires is essential for proper operation of the harness. All available In Cabin connections are outlined below:

Any unused connections should be insulated to avoid damage to this harness and your ECU.

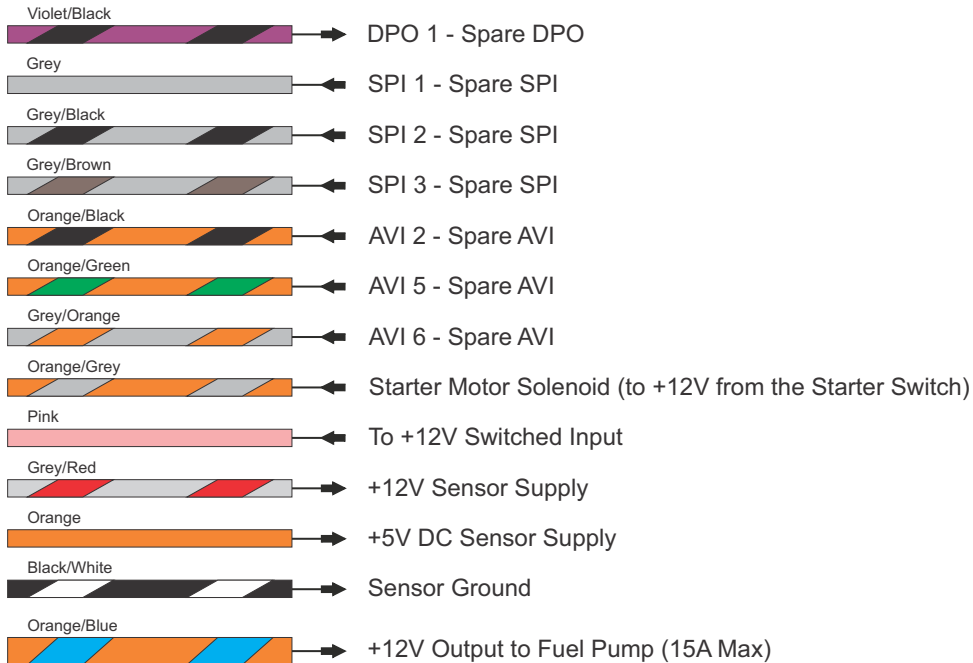

Figure 17 - In Cabin Harness Connections

Spare Digital Pulsed Output (DPO1)

When the output is activated by the ECU, the output will switch to ground. Devices such as solenoid valves and shift lights can be run directly from the output provided that they do not exceed the maximum current draw of 1A. However high current devices such as thermofans and additional fuel pumps must be activated through a relay. A relay can be wired between the DPO and the supplied +12V DC on this connector. This way the output is only switching the relay and not a high current draw device.

The Digital Pulsed Outputs are limited to 1A Max current draw.

Analogue Voltage Inputs (AVI2, AVI5, AVI6)

The Analogue Voltage Input (AVI) can accept variable voltages from 0V to 5V. These inputs can also accept switched inputs that change between two different voltage levels. The switch on voltage and switch off voltage define what the thresholds are between the on and off states. The voltage can be viewed as a channel in the NSP software to determine thresholds for a switched input.

The AVI-2, AVI-5 and AVI-6 labelled wires are spare Analogue Voltage Inputs. These inputs can be programmed within the NSP Software to read variable voltage inputs such as:

- O2 Sensors
- Pressure Sensors
- Temperature Sensors
- Various Switches

For a full list of input options and explanations please go to the help section within the NSP Software.

Synchronised Pulsed Inputs (SPI1, SPI2, SPI3)

The Synchronised Pulsed Input (SPI) can accept digital or retractor input that can vary in duty and / or frequency. These inputs can be programmed within the NSP Software to read inputs such as:

- Vehicle Speed Sensor
- Crank Angle Sensor
- Cam Angle Sensor
- Fuel Flow Sensor

For a full list of output options and explanations please go to the help section within the NSP Software.

Switched +12VDC Input

This input must be connected to a +12VDC switched ignition source that doesn't turn off when the ignition key is at the start position. This is required to turn on the Haltech ECU and all relays contained within the fusebox.



Figure 18 - Switched +12VDC input wire

Starter Switch Signal

This wire in the cabin section of the harness needs to connect to a +12VDC starter switch signal from the ignition key. This wire also directly connects to the starter motor solenoid at the other end of the harness to drive the starter motor when the engine needs to crank over.



Figure 19 - Starter switch signal wire

Fuel Pump Output (Fuel Pump +12V DC)

The fuel pump output supplies a continuous +12V DC supply to the fuel pump when the engine is running.

This output wire is rated for a max continuous current draw of 15A (through relay located inside the fuse box).

The fuel pump output wire can be connected directly to the positive side of the fuel pump, providing the pump in use will draw less than 15A of current under full load.

If your pump will draw more than 15A or if dual pumps are to be used, it is recommended that you use this wire to control a relay to turn on the fuel pumps.



Figure 20 - Fuel Pump Output wire, 15A Max Continuous Current

Fuse Box

The Haltech fuse box is connected to the harness.

Contained within the Haltech fuse box is 4 fuses and 4 relays.

Each fuse protects the corresponding relay output (ie fuse #1 protects relay output #1, fuse #2 protects relay output #2 and so on).

The Haltech fuse box can handle a maximum continuous current draw of 75A, exceeding this value may cause damage to the fuse box. Please ensure all auxiliary devices, fans and fuel pumps connected **do not** exceed the supplied fuse box current limit.

The functions of each of the relays are outlined below:

Fuse #	Relay #	Function	Fuse Required
F1	R1	+12V Output to ECU	10A
F2	R2	+12V Output to Injectors	20A
F3	R3	+12V Output to Ignition	15A
F4	R4	+12V Output to Fuel Pump	20A
F5	R5	Unpopulated	-
F6	R6	Unpopulated	-

Figure 21 - Haltech fuse box relay allocation table

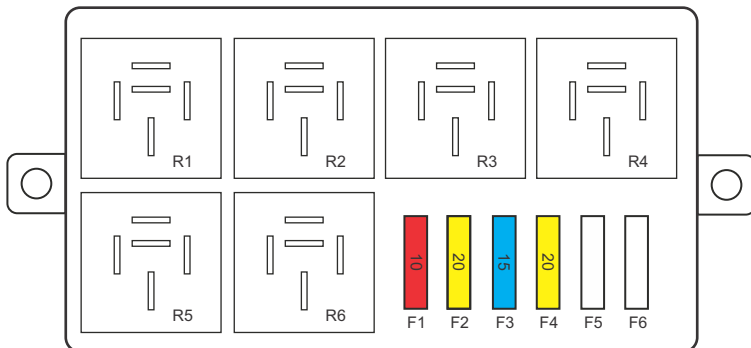
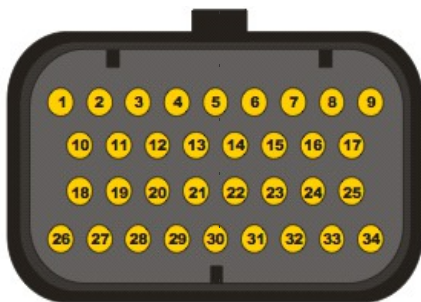

Figure 22 - Haltech fuse box layout

Harness Pinout



(34 Pin Connector)

ECU Connector (34 Pin Plug)	Function	Description
A1	DPO 2	Spare Output (In Engine Bay)
A2	AVI 4	Oil Pressure Sensor (Fitment of Oil Pressure Sensor Required)
A3	IGN 1	Ignition Coil #1
A4	IGN 2	Ignition Coil #2
A5	IGN 3	Ignition Coil #3
A6	IGN 4	Ignition Coil #4
A7	-	-
A8	-	-
A9	+5V	+5V DC Sensor Supply
A10	BATTERY GROUND	Battery Negative
A11	BATTERY GROUND	Battery Negative
A12	-	-
A13	IGNITION INPUT	Ignition Switch (In Cabin Loom)
A14	AVI 10	Throttle Position Sensor
A15	AVI 9	Map Sensor (Fitment of 5 Bar Map Sensor Required)
A16	AVI 2	Spare Synchronised Pulsed Input (In Cabin Loom)
A17	AVI 3	Fuel Pressure Sensor (Fitment of Fuel Pressure Sensor Required)
A18	DPO 1	Spare Output (In Cabin Loom)
A19	INJ 1	Primary Injector Output #1
A20	INJ 2	Primary Injector Output #2
A21	INJ 3	Secondary Injector Output #1
A22	INJ 4	Secondary Injector Output #2
A23	DPO 3	Thermofan relay
A24	DPO 5	Fuel Pump (+) 15A Max
A25	DPO 6	Engine Control Relay
A26	+12V (INJ)	Fused Power
A27	-	-
A28	-	-
A29	-	-
A30	-	-
A31	STEP1 P1	Oil Metering Pump
A32	STEP2 P2	Oil Metering Pump
A33	STEP3 P3	Oil Metering Pump
A34	STEP4 P4	Oil Metering Pump



(26 Pin Connector)

ECU Connector (26 Pin Plug)	Function	Description
B1	TRIGGER	Crankshaft Position Sensor (+)
B2	HOME	Cam Position Sensor (+)
B3	AVI 7	Air Temperature Sensor(Fitment of Air Temperature Sensor Required)
B4	AVI 8	Coolant Temperature Sensor
B5	TRIGGER -	Crankshaft Position Sensor (-)
B6	HOME -	Cam Position Sensor (-)
B7	SPI 4	Spare Synchronised Pulsed Input (In Engine Bay)
B8	SPI 1	Spare Synchronised Pulsed Input (In Cabin Loom)
B9	SPI 2	Spare Synchronised Pulsed Input (In Cabin Loom)
B10	SPI 3	Spare Synchronised Pulsed Input (In Cabin Loom)
B11	+12V (ECU)	Fused Power
B12	AVI 6	Spare Analogue Voltage Input (In Cabin Loom)
B13	AVI 1	Oil Metering Pump
B14	SIGNAL GROUND	Signal Ground for Input Sensors
B15	SIGNAL GROUND	Signal Ground for Input Sensors
B16	SIGNAL GROUND	Signal Ground for Input Sensors
B17	-	-
B18	-	-
B19	DPO 4	Spare Output (In Engine Bay)
B20	AVI 5	Spare Analogue Voltage Input (In Cabin Loom)
B21	KNOCK 1	Knock Sensor (Fitment of Knock Sensor Required)
B22	-	-
B23	CAN HIGH	Auxiliary CAN Connector
B24	CAN LOW	Auxiliary CAN Connector
B25	-	-
B26	-	-

Haltech

V2.0 (Harness Rev 1.4)

Need more help?



AUS: +61 2 9729 0999 **USA East:** (888) 298 8116 **USA West:** (949) 490 5660
Europe: +43 720 883968 **UK:** 0121 285 6650 **NZ:** 09 887 0616



www.haltech.com/support



support@haltech.com